

Supply Fan (Cabinet Fan) | FV-01NAP1

Feature

- DC (Direct Current) motor
- Well lubricated ball bearing for long life operation
- Unique motor mount for low noise
- Pre filter blocks large particles
- PM2.5 filter captures PM2.5 particles effectively
- Compact size with embedded terminal box
- 2 speed selectable
- Ready for IAQ panel connection



Dimension

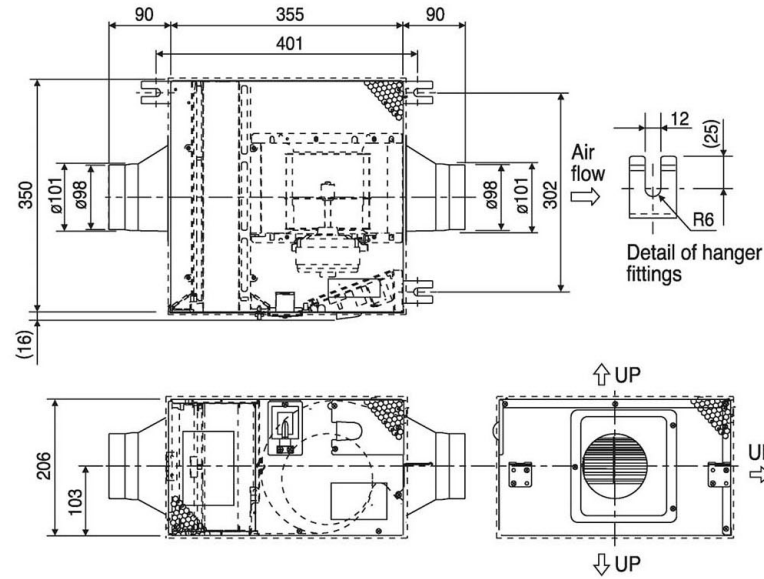

Performance Data

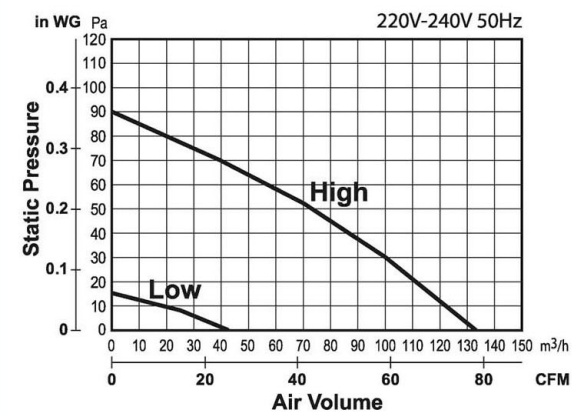

Specification

Voltage			Air Volume		Consumption	Noise	Weight	Duct Size
[V]	[Hz]		[m ³ /h]	[CFM]	[W]	[dB (A)]	[kg]	[mm]
220 - 240	50	Hi	133	78	10	23	6.9	ø 100
		Lo	42	25	3.3	18		

Test Condition

- Air volume, electric characteristic and noise are specified at the static pressure of 0 Pa
- The values of noise level is A weighted average sound pressure level, the mean value are measured by our company, within +3 to -7 dB tolerance
- The values of noise level are measured at 1.5 m apart from the side of fan body when ducts are connected on both inlet and outlet side
- The values of air volume are the mid-points of results measured by our company, within ±10% tolerance

LIVING IN FRESH ENVIRONMENT



Supply Fan (Cabinet Fan) FV-01NAP1



PM_{2.5} refers to dangerous particles of pollutants that are less than 2.5µm in diameter. These can be easily inhaled to lung and cause health issues.

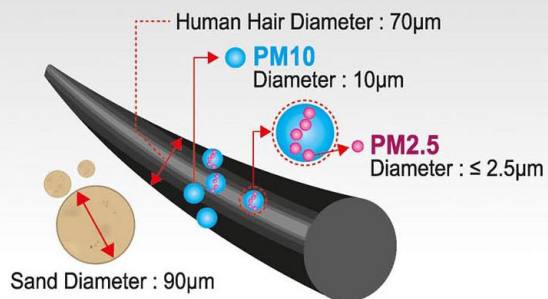

PM_{2.5} on health effects:

- easy to penetrate the thoracic cavity of the respiratory system
- respiratory and cardiovascular morbidity increases, such as aggravation of asthma, respiratory symptoms
- increases the mortality caused by cardiovascular and respiratory diseases and lung cancer

Achieve Indoor Air Quality (IAQ) by Supply Ventilation

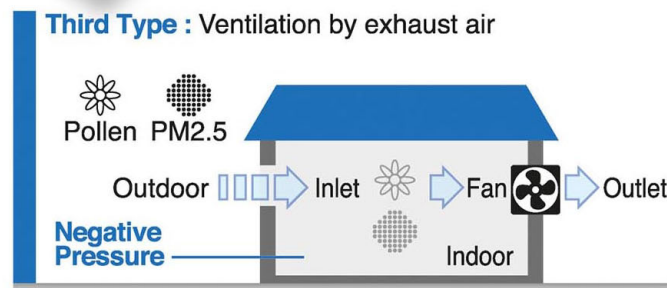
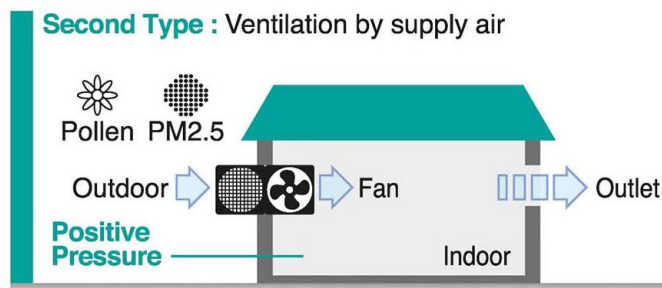
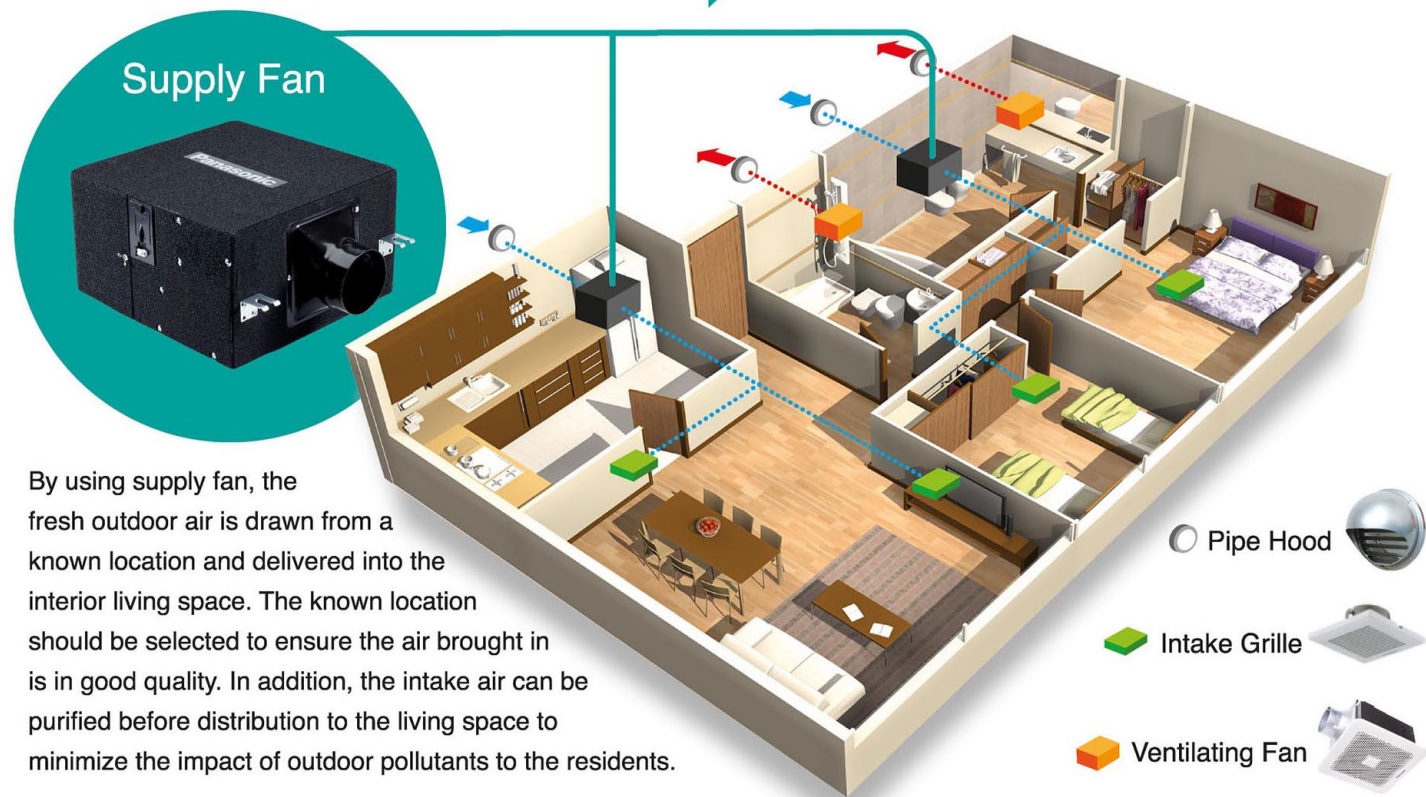

Feature Highlight

Energy Efficient

- The fan is adopted with DC (Direct Current) Motor to reduce power consumption for energy saving.
- Temperature rise of DC motor is lower than AC (Alternating Current) Motor that the lifetime of DC motor is comparatively longer

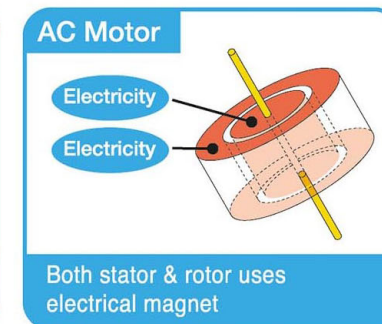
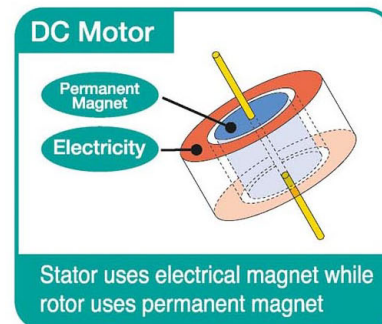

Ready for IAQ Panel

- Able to link with IAQ panel for operation control
- Available to auto operation by sensor with IAQ panel



Effective Filtration

- PM_{2.5} filter can capture tiny particles such as PM_{2.5} particles effectively
- Pre filter blocks large particles, dust and larvae, etc. from outdoor

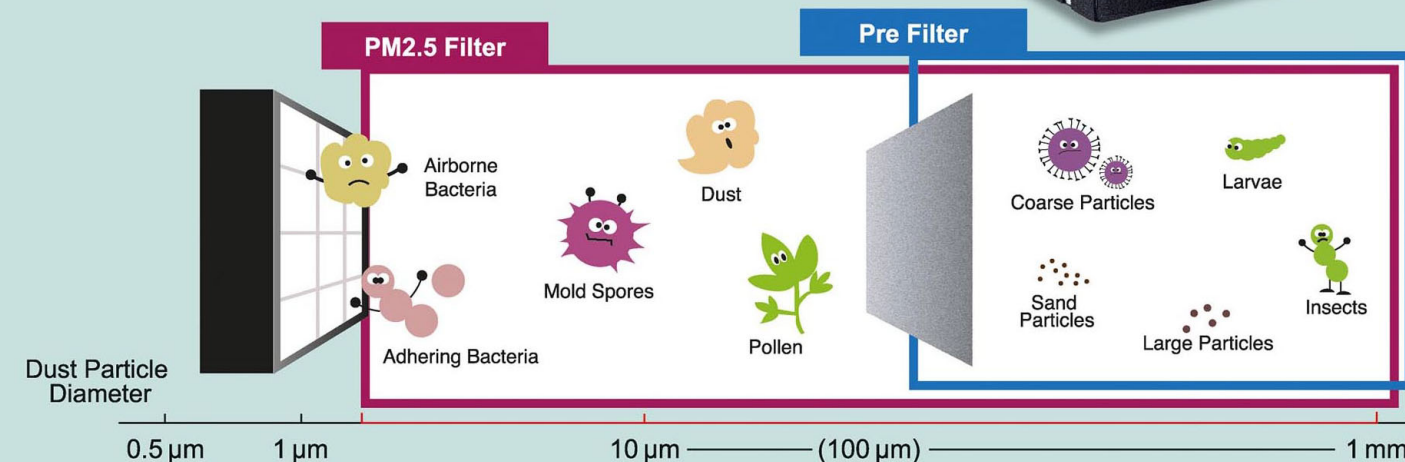

Low Noise Structure

Unique design of the motor mounting structure reduces transmission of vibration during operation. It can eliminate abnormal noise significantly.

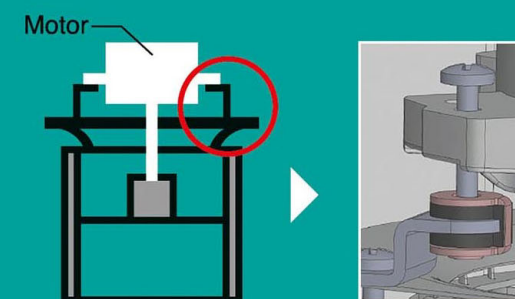

With IAQ panel linkage, additional features would be available

1. Temperature, humidity, level of PM_{2.5} and CO₂ in the room can be seen at a glance
2. Selection of operation mode
 - Auto (speed adjustment by PM_{2.5} & CO₂ level)
 - Silent (quiet operation)
 - Manual (5-speed adjustable)
3. Filter maintenance indication

